

Incremental Rotary Encoder

Mini Size
Housing Dia.:50mm;
Solid Shaft Dia.:8mm;

GI-S50 Series



- ▶ Housing Diameter:50mm;
- ▶ Solid Shaft Diameter:8mm;
- ▶ Resolution: Max.30000ppr;
- ▶ Supply Voltage:5v,8-29v;
- ▶ Output Format: NPN/PNP open collector, Push pull, Line Driver;
- ▶ Output Signal: A B / A B Z / A B Z & A- B- Z-;
- ▶ Widely used in various fields of automatic control and measurement system,such as machinery manufacturing, shipping, textile, printing, aviation, military industry Testing machine, elevator, etc.
- ▶ Vibration-resistant, corrosion-resistant, pollution-resistant;



Product characteristics

Housing Dia.:	50mm
Solid Shaft Dia.:	8mm

Electrical Data

Resolution:	Max.30000ppr			
Output Format:	NPN/PNP open collector, Push pull, Line Driver, Voltage Output;			
Output Signal:	A/A B / A B Z / A B Z & A- B- Z-;			
Supply Voltage:	5V, 8-29V			
Max. Frequency Response	300Khz			
	Open Collector	Voltage Output	Line Driver	Push Pull
Consumption current	≤80mA;	≤80mA;	≤150mA;	≤80mA;
Load current	40mA;	40mA;	60mA;	40mA;
VOH	Min.Vcc x 70%;	Min.Vcc - 2.5v	Min.3.4v	Min.Vcc - 1.5v
VOL	Max.0.4v	Max.0.4v	Max.0.4v	Max.0.8v

Mechanical Data

Start Torque	0.08 N•M
Max. Shaft Loading	Axial: 25N, Radial:10N;
Max. Rotary Speed	5000rpm
Weight	160g

Environment Data

Working Temp.	-30~80°C
Storage Temp.	-40~80°C
Protection Grade	IP54

Wave Form

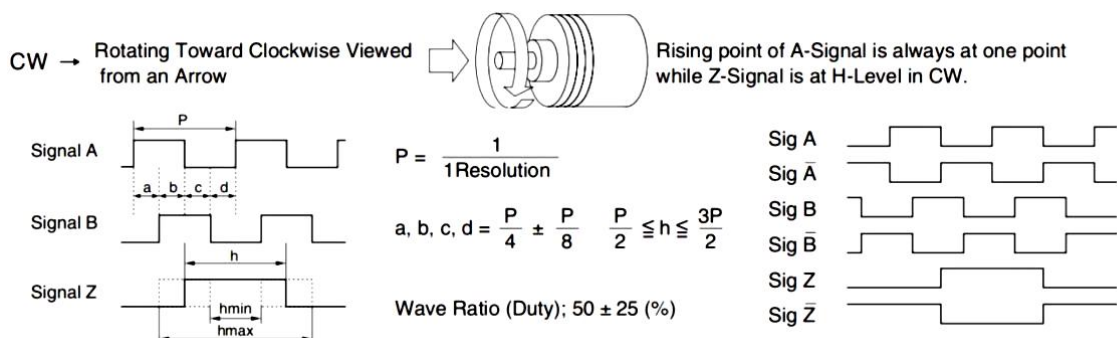

Circuit of Output Signal

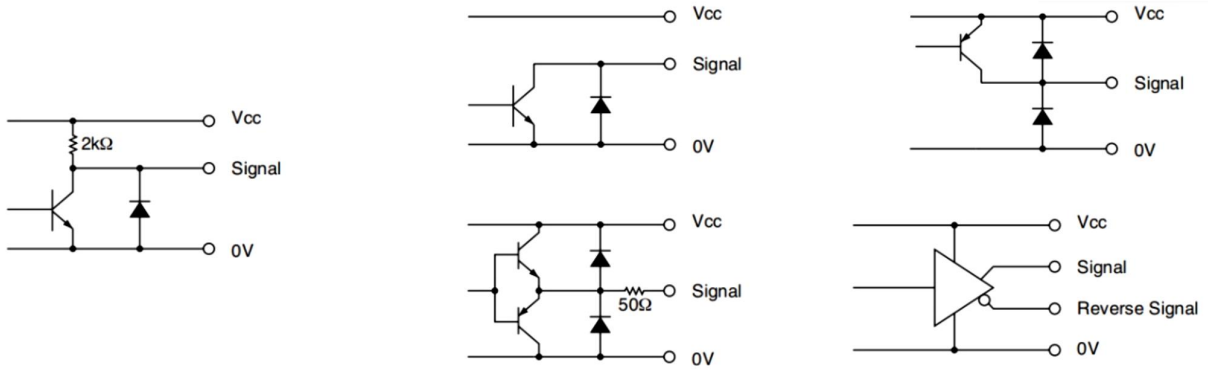

Ordering Code

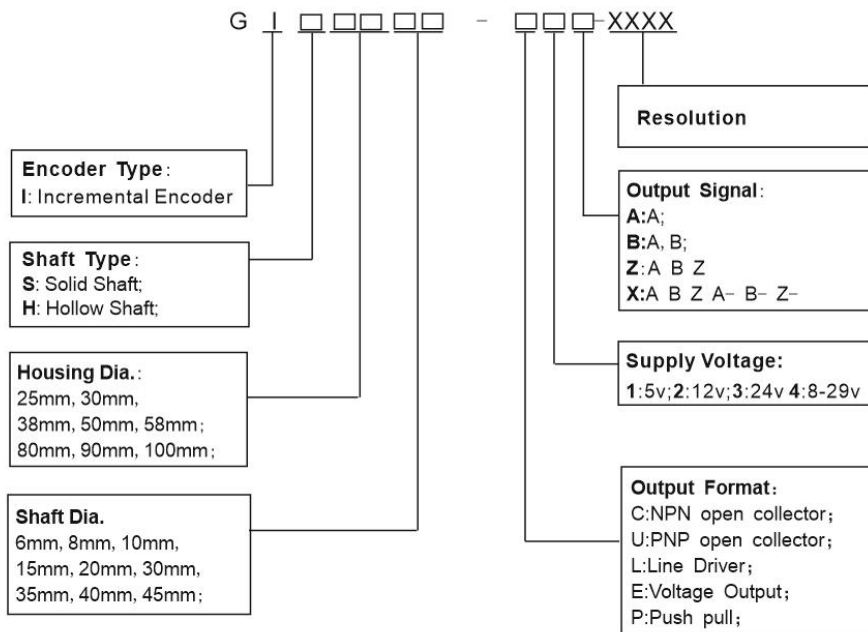

Dimensions

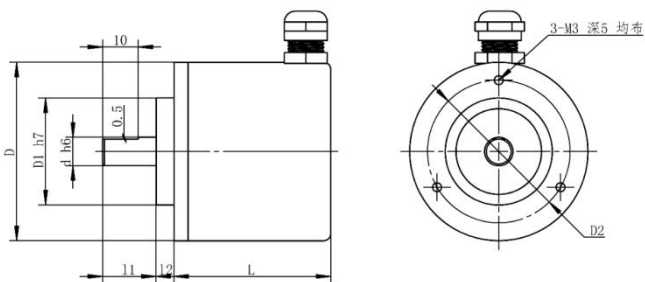

D	38	50	58
d	6	8	10
D1	20	30	36
D2	30	40	48
L	35	35	44
11	15	15	20
12	5	5	10